

LIST OF PARTS

FOR

CONSEW

MODELS

223, 223R

227, 227R

227FS, 227RFS

CYLINDRICAL BED MACHINES



CONSOLIDATED SEWING MACHINE CORP.

INDEX

	Page
Thread take up lever, needle bar for all models.....	1
Arm shaft, feeding mechanism for all models	3
Lifting lever, face plate, slide plate for all models	5
Presser bar, lifting rock shaft, vibrating presser foot for all models..	7
Hook driving shaft, rotating hook, timing belt for all models.....	9
Thread tension, feed driving rock shaft, feeder, needle plate for all models.....	11
Accessories	13
Reverse stitch mechanism	15
Special parts for 227FS and 227RFS only	17
Presser bar, needle bar, needle plate, feeder for 223 and 223R only	19

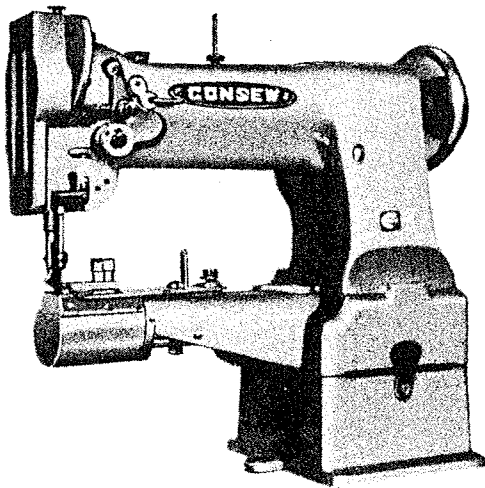

Model 227FS

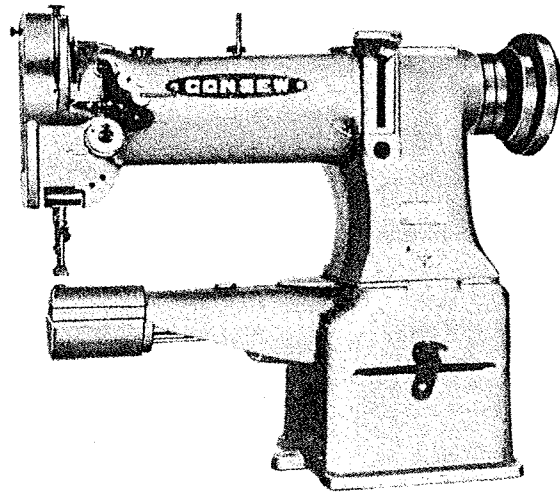

Model 227R

THREAD TAKE UP LEVER, NEEDLE BAR, ETC. FOR ALL MODELS EXCEPT PARTS MARKED *

Fig. No.	Parts No.	Quantity	Name
1	10525	1	Screw for 10527
2	10527	1	Take up lever hinged stud
3	10726	1	Oil wick for 10527
4	10526	1	Take up lever
5	10551	1	Needle bar connecting link oil guard
6	10650	1	Screw for 10551
7	10529	1	Take up lever driving stud
8	10728	1	Oil wick for 10529
9	10522	1	Needle bar crank position screw (B)
10	10521	1	Needle bar crank position screw (A)
11	10520	1	Needle bar crank
12	10524	1	Screw for 10523 (A)
13	10764	1	Screw for 10523 (B)
14	10523	1	Needle bar connecting link stud
15	10726	1	Oil wick for 10523
16	10525	1	Screw for 10537
17	10537	1	Needle bar rock frame hinged stud
18	10561	1	Screw for 10560
19	10560	1	Needle bar rock frame position bracket
20	* 10536	1	Needle bar rock frame
21	10528	1	Needle bar connecting link
22	10726	1	Oil wick for 10531
23	* 10531	1	Needle bar connecting stud
24	* 10532	1	Screw for 10531
25	* 10530	1	Needle bar
26	* 10533	1	Needle bar thread guide
27	10535	1	Needle bar set screw
28	10534	1	Thread guide screw
29	6332	1	Needle
30	10701	1	Arm shaft bushing oil packing thumb screw
31	10725	2	Oil felt for 10562
32	10729	1	Oil wick for 10562
33	10563	1	Washer for 10562
34	10562	1	Arm shaft bushing (front)
35	13058	1	Foot lifter lifting lever stop stud
36	13084	2	Nut for 13057
37	13057	1	Foot lifter lifting lever stop
38	10578	1	Needle bar rock frame rock shaft
39	10582	1	Needle bar rock frame slide block
40	10580	1	Needle bar rock frame slide block stud
41	10581	1	Screw for 10580
42	13077	1	Needle bar rock frame shaft crank
43	10519	1	Screw for 13077
44	10636	1	Nut for 13134
45	10728	1	Oil wick for 13071
46	13071	1	Needle bar rock frame shaft crank connection
47	13134	1	Screw for 13071

Parts marked * are not necessary for 223 & 223R

ARM SHAFT, FEEDING MECHANISM FOR ALL MODELS

Fig. No.	Parts No.	Quantity	Name
1	10566	2	Screw for 13075
2	13075	1	Arm shaft ball bearing adapter sleeve
3	10571	1	Screw for 13074
4	13074	1	Machine arm bearing adapter
5	10567	1	Arm shaft ball bearing
6	10568	1	Ball bearing retaining washer
7	10506	1	Arm shaft oil packing stop screw
8	10724	1	Arm shaft oil wick
9	13060	1	Arm shaft
10	13065	2	Feed driving eccentric regulating bracket stop screw
11	13076	2	Nut for 13065
12	13062	1	Feed driving eccentric regulating flange
13	13063	1	Position screw for 13062
14	10764	1	Screw for 13062
15	10764	1	Screw for 13069
16	13069	1	Feed driving eccentric regulating screw
17	13064	1	Feed driving eccentric regulating bracket
18	13066	1	Feed driving eccentric regulating plunger
19	13067	1	Spring for 13066
20	13068	1	Screw for 13067
21	10545	1	Screw for 13070
22	13070	1	Feed driving connection
23	13082	1	Washer for 13061
24	13061	1	Stitch regulator
25	10576	1	Screw for 13039 (A)
26	10579	1	Screw for 13039 (B)
27	13039	1	Balance wheel

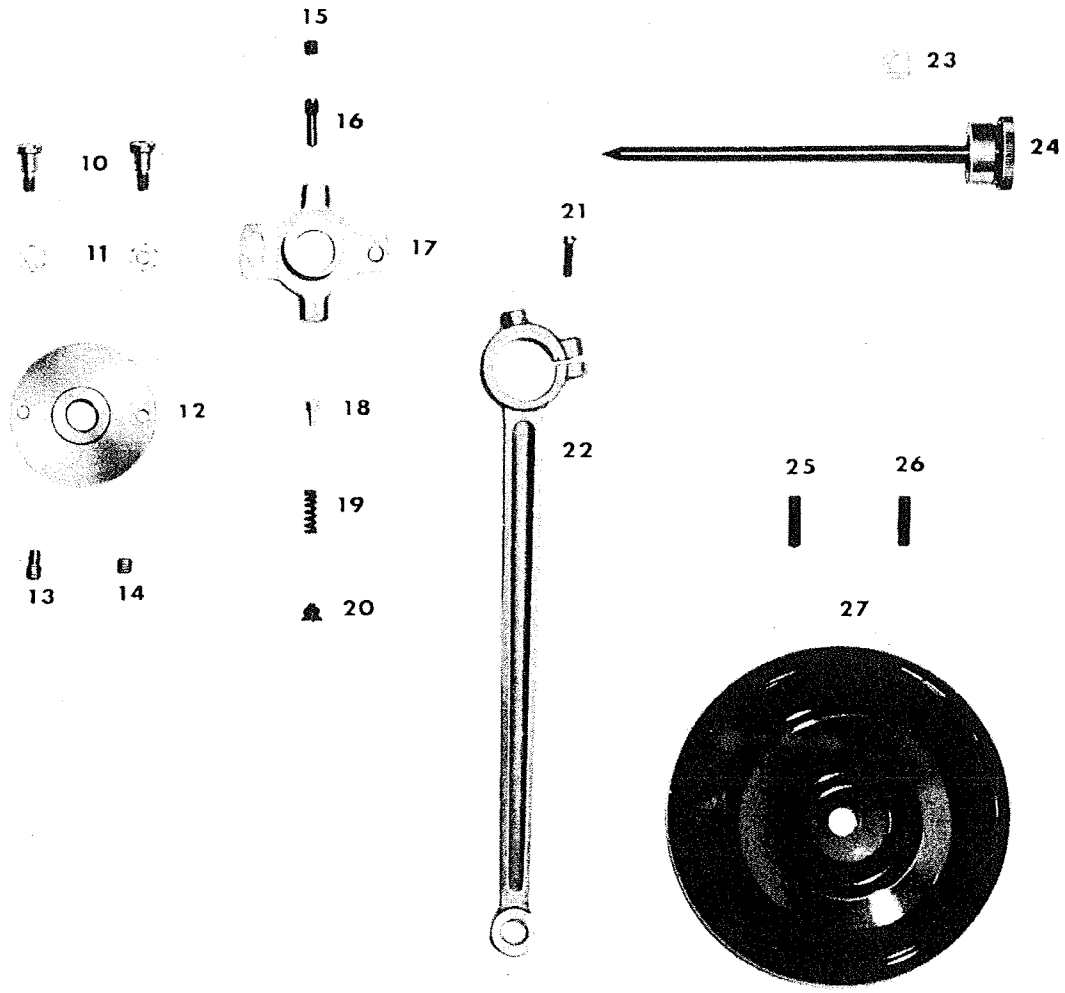
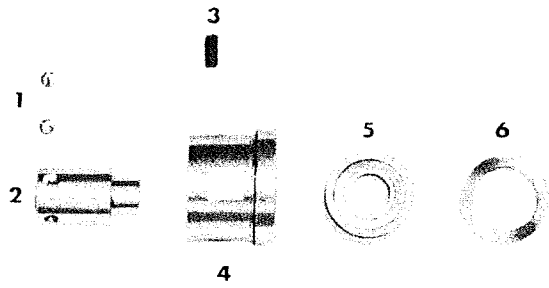

5

LIFTING LEVER, FACE PLATE, SLIDE PLATE FOR ALL MODELS EXCEPT PARTS MARKED *

Fig. No.	Parts No.	Quantity	Name
1	10712	1	Set screw for 13056
2	13056	1	Foot lifter lifting lever
3	13059	1	Foot lifter lifting lever spring
4	10707	1	Presser bar spring regulating screw
5	10706	1	Presser bar spring support screw
6	10705	1	Presser bar flat spring
7	13079	1	Chain
8	10699	1	Face plate thumb nut
9	10698	1	Face plate
10	10700	1	Face plate position pin
11	10704	1	Arm cap screw
12	10703	1	Arm cap screw washer
13	10702	1	Arm cap
14	13099	1	Bed end cover
15	13027	4	Bed slide guide plate screw
16	13025	1	Bed slide guide plate (rear)
17	* 13024	1	Bed slide
18	13026	1	Bed slide guide plate (front)
19	13005	6	Bed hinge screw
20	13004	1	Bed hinge
21	13003	1	Machine base
22	10712	1	Screw for 13006
23	13006	1	Bed clamp
24	13007	1	Bed clamp thumb screw
25	13008	1	Bed clamp thumb screw washer

Parts marked * are not necessary for 227FS & 227RFS

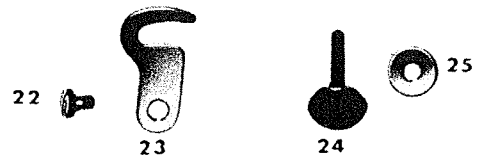
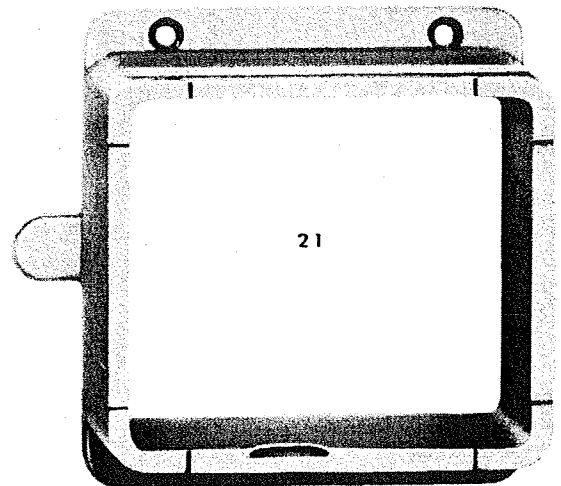
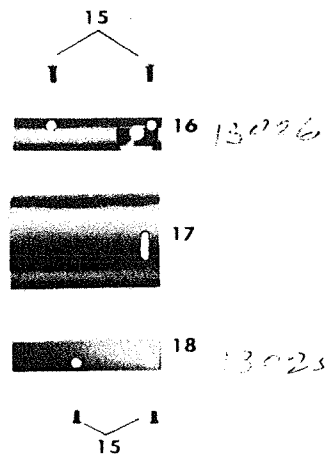
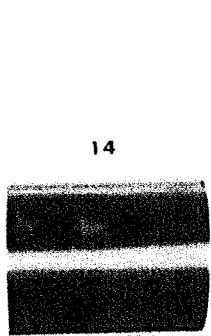
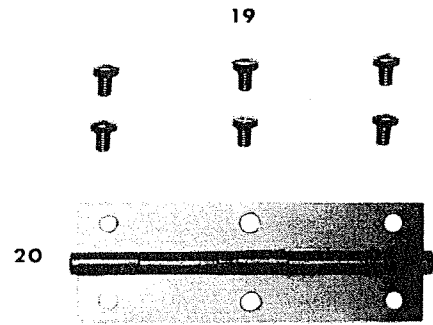
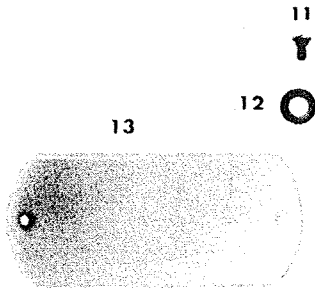
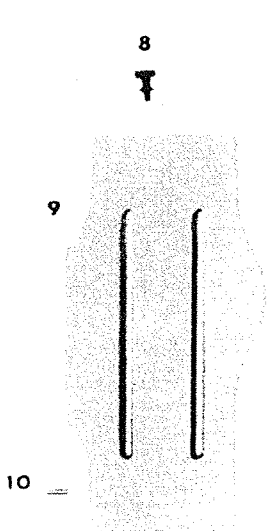
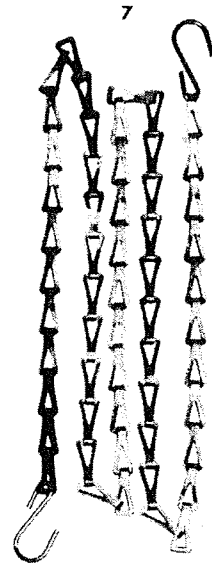
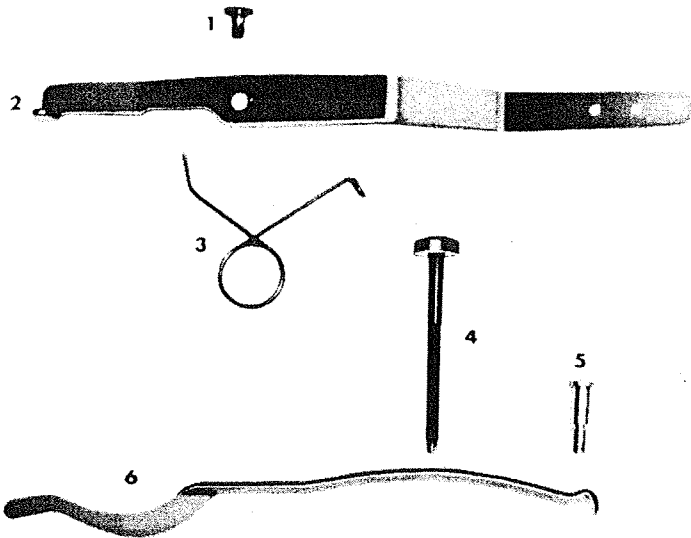

7

PRESSER BAR, LIFTING ROCK SHAFT, VIBRATING PRESSER FOR ALL MODELS EXCEPT 223 & 223R

Fig. No.	Parts No.	Quantity	Name
1	10540	1	Presser bar
2	10761	1	Screw for 10543
3	10543	1	Presser bar position guide
4	10538	1	Presser bar bushing (upper)
5	10761	2	Screw for 10538
6	10662	1	Screw for 10541
7	10541	1	Presser bar position guide bracket
8	10559	1	Lifting bell crank set screw
9	10544	1	Presser bar lifting bracket
10	10545	1	Presser bar lifting bracket screw
11	10660	1	Presser bar lifter hinge screw
12	* 13055	1	Presser bar lifter
13	10547	1	Tension release spring
14	10546	1	Tension release slide
15	10549	1	Presser bar spring bracket
16	10532	1	Set screw for 10549
17	10539	1	Presser bar bushing (lower)
18	10664	1	Lifting presser foot screw
19	* 10796	1	Lifting presser foot
20	10514	2	Lifting rock shaft bushing
21	10515	1	Lifting rock shaft
22	10516	1	Lifting bell crank link screw stud
23	10517	1	Lifting bell crank screw stud
24	10775	1	Lifting eccentric connection hinge screw
25	10703	1	Washer for 10775
26	16505	1	Lifting eccentric connection crank
27	10754	1	Screw for 10751
28	10774	1	Lifting eccentric connection collar
29	10776	1	Wing nut for 10774
30	10548	1	Presser bar lifting guide screw
31	10557	1	Lifting bell crank link (large)
32	10558	1	Lifting bell crank
33	10728	1	Oil wick for 10556
34	10556	1	Vibrating presser bar connecting link (small)
35	10728	1	Oil wick for 10555
36	10555	1	Vibrating presser bar
37	* 10795	1	Vibrating presser foot
38	10662	1	Screw for 10795
39	10554	1	Vibrating presser bar extension spring
40	10708	1	Vibrating presser bar thumb screw
41	10553	1	Vibrating presser bar extension
42	10772	1	Lifting eccentric connection
43	10773	1	Needle bearing
44	10771	1	Lifting eccentric
45	10566	2	Screw for 10771

Parts marked * are not necessary for 227FS & 227RFS

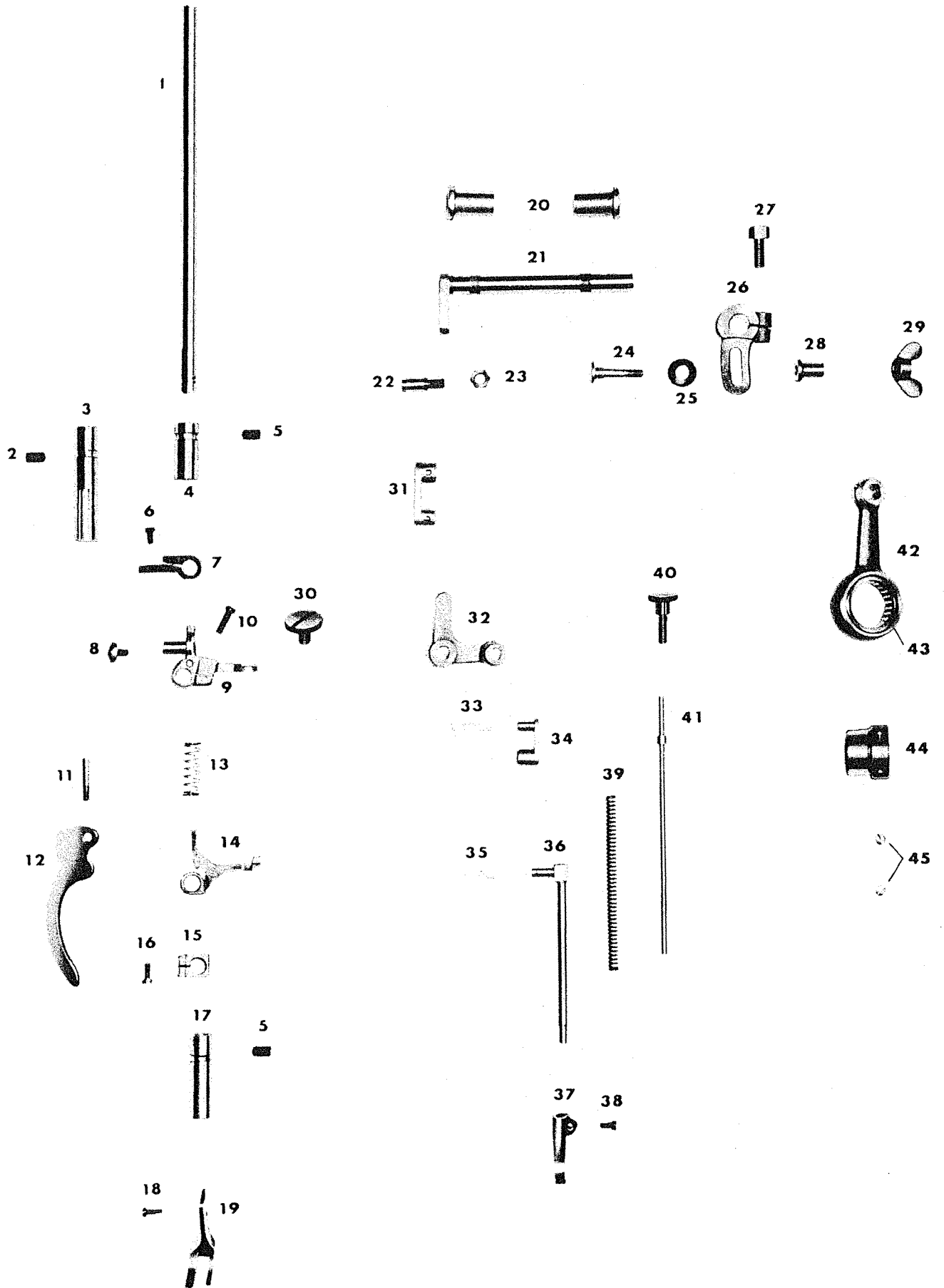

HOOK DRIVING SHAFT, ROTATING HOOK, TIMING BELT FOR ALL MODELS EXCEPT PARTS MARKED *, + and -

Fig. No.	Parts No.	Quantity	Name
1	10656	1	Bobbin
2	13086	1	Rotating hook
3	13087	1	Rotating hook screw
4	13042	1	Hook washer
5	13041	1	Bobbin case lever
6	13040	1	Bobbing case lever eccentric
7	13038	1	Bobbin case lever fulcrum with stud
8	10650	1	Screw for 13038
9	13036	2	Hook saddle screw
10	13037	2	Hook saddle screw washer
11	13035	1	Hook saddle
12	13081	1	Oil wick for 13035 (A)
13	13034	1	Hook bevel gear socket
14	13033	3	Hook bevel pinion set screw
15	13032	1	Hook bevel pinion
16	10764	1	Screw for 13028
17	13028	1	Hook driving shaft bushing
18	13046	1	Hook driving shaft lock stud
19	13047	1	Hook driving shaft lock stud spring
20	13045	1	Hook driving shaft lock stud socket
21	13048	1	Hook driving shaft lock stud pin
22	10639	1	Hook driving gear screw (A)
23	10766	1	Hook driving gear screw (B)
24	13044	1	Hook driving shaft lock ratchet
25	13050	2	Hook driving shaft collar set screw
26	13049	1	Hook driving shaft collar
27	10767	1	Screw for 13029
28	13029	1	Hook driving shaft bushing (right)
29	10574	3	Arm shaft connecting belt pulley spring flange
30	10764	1	Screw for 10570
31	10571	1	Screw for 10569 (B)
32	* 10521	1	Screw for 10569 (A)
33	+ 10570	1	Arm shaft connecting belt pulley position screw
34	10569	1	Arm shaft connecting belt pulley
35	10621	1	Arm shaft connecting belt
36	13043	1	Hook driving shaft
37	- 13030	1	Feed lifting eccentric
38	13031	1	Screw for 13030 (A)
39	13085	1	Screw for 13030 (B)
40	13054	1	Arm shaft connecting belt timing plate
41	10597	2	Screw for 13054
42	10612	2	Screw for 10611
43	10611	1	Safety clutch collar
44	10610	1	Safety clutch pulley
45	10581	1	Screw for 10614
46	10614	1	Safety clutch locking lever spring hinge pin
47	10615	1	Safety clutch locking lever flat spring
48	10619	1	Safety clutch locking lever spring
49	10617	1	Safety clutch ratchet
50	10618	1	Safety clutch ratchet connecting link
51	10620	1	Pin for 10618
52	10581	1	Screw for 10613
53	10613	1	Safety clutch locking lever hinge stud
54	10616	1	Safety clutch locking lever

Part marked * is not necessary for 223R, 227R & 227RFS

Part marked + is for only 223R, 227R & 227RFS

Part marked - is not necessary for 227FS & 227RFS

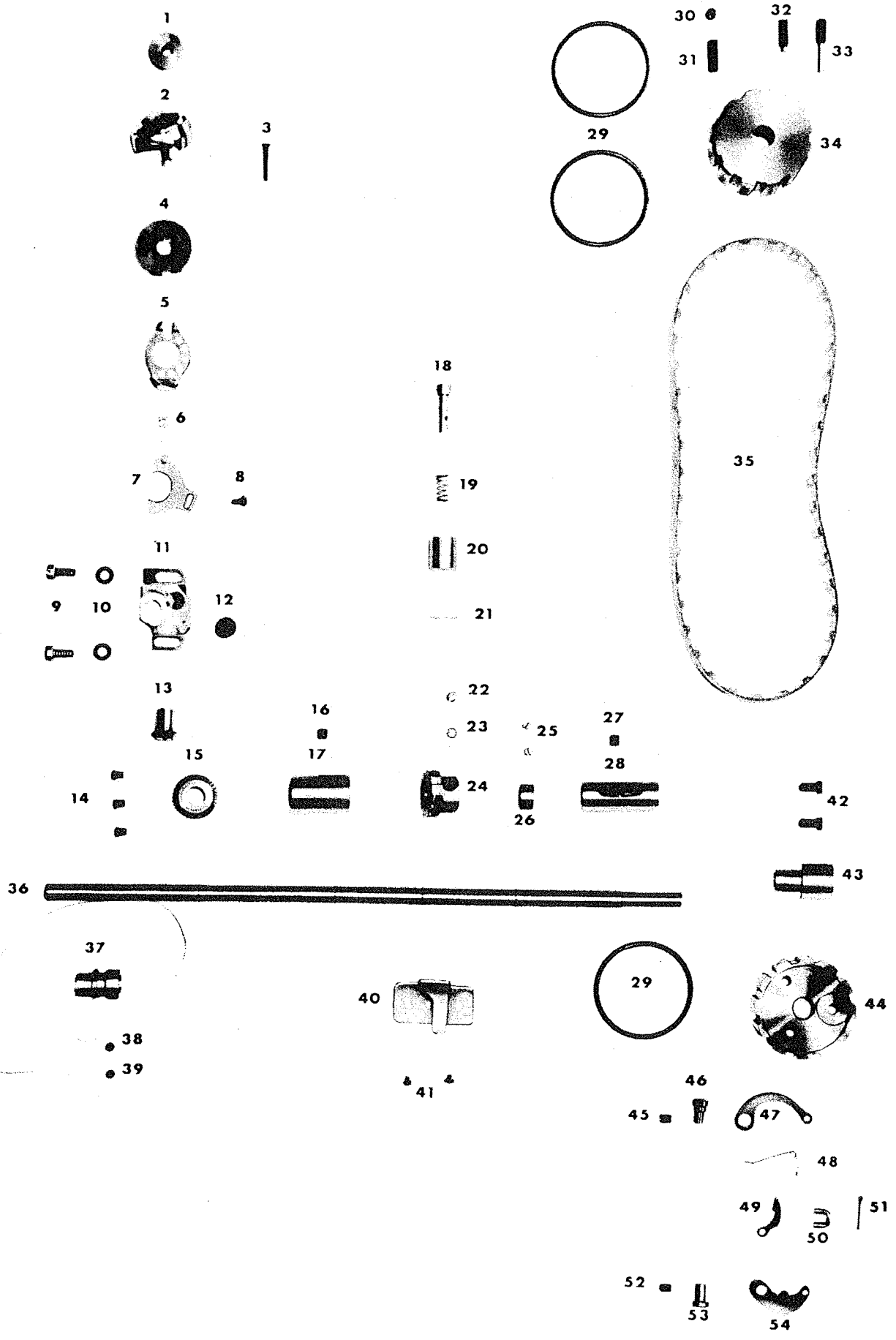

THREAD TENSION, FEED DRIVING ROCK SHAFT, FEEDER, NEEDLE PLATE FOR ALL MODELS EXCEPT PARTS MARKED * +

Fig. No.	Parts No.	Quantity	Name
1	10682	1	Thread guide (upper)
2	10683	1	Thread guide (middle)
3	10759	1	Thread guide (lower)
4	10685	3	Thread guide screw
5	10681	1	Thread retainer set screw
6	10680	1	Thread retainer
7	10709	1	Spool pin
8	10720	1	Tension release lever rod
9	10679	2	Tension release lever rod screw
10	10678	1	Tension release lever
11	10675	1	Tension bracket
12	10789	1	Tension stud
13	10791	1	Pin for 10675
14	10561	1	Screw for 10675
15	10691	2	Thread disc
16	10793	1	Tension release plunger
17	10692	1	Tension release washer
18	10693	1	Tension release spring
19	10697	3	Tension thumb nut
20	10792	1	Thread controller stud
21	10545	1	Screw for 10792
22	10689	1	Thread controller spring
23	10690	1	Thread controller spring stop
24	10650	1	Screw for 10690
25	10695	1	Tension controller disc screw
26	10694	1	Tension controller disc
27	13073	2	Bed cylinder cap pin
28	13011	2	Bed cylinder cap screw
29	13010	1	Bed cylinder cap
30	13080	1	Oil wick for 13012
31	13076	1	Nut for 13012
32	13012	1	Feed driving rock shaft bearing
33	13023	2	Needle plate set screw
34	* 13022	1	Needle plate
35	10561	1	Feed dog set screw
36	* 13020	1	Feed dog
37	+ 13019	1	Feed lifting fork
38	+ 13016	1	Feed bar
39	+ 10650	2	Feed lifting fork gib screw
40	+ 13017	1	Feed lifting fork gib
41	13015	1	Feed bar hinge screw
42	13013	1	Feed driving rock shaft
43	13083	1	Liner for 13013
44	3052	1	Set screw for 13015
45	13033	1	Screw for 13049
46	13049	1	Feed driving shaft collar
47	10766	1	Screw for 13029
48	13029	1	Feed driving shaft bushing
49	11185	1	Nut for 13072
50	13072	1	Feed driving connection hinge screw
51	13053	1	Feed driving rock shaft crank
52	13078	1	Screw for 13053
53	10760	1	Oil wick for thread guide

Parts marked * are not necessary for 227FS, 227RFS, 223 & 223R

Parts marked + are not necessary for 227FS & 227RFS

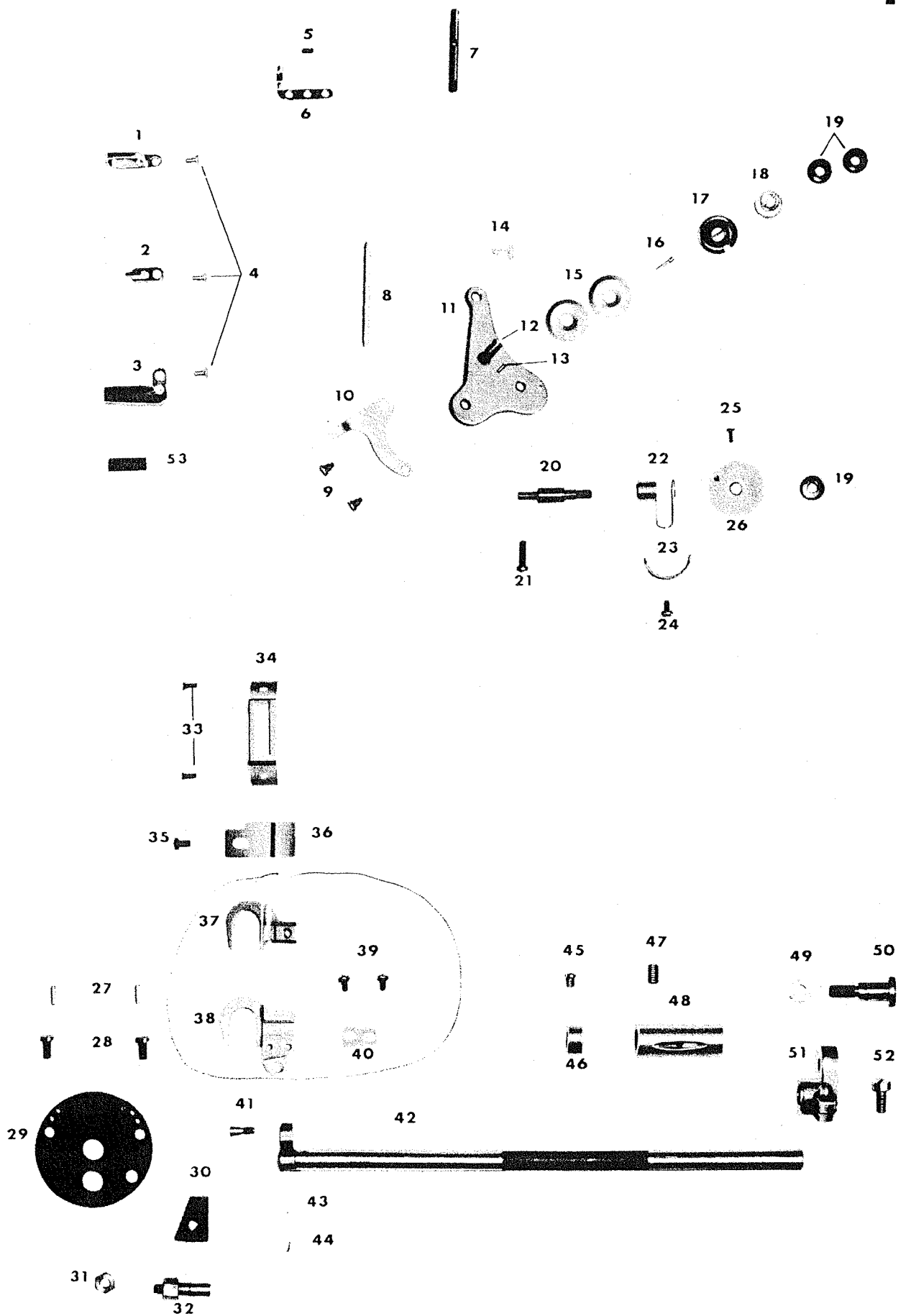

ACCESSORIES FOR ALL MODELS

Fig. No.	Parts No.	Quantity	Name
1	8132	1	Accessories box
2	10734	1	Bobbin winder set
3	13094	1	Pedal
4	10656	3	Bobbin
5	6332	3	Needle
6	10748	1	Double head wrench
7	8118	1	Screw driver (large)
8	8120	1	Screw driver (middle)
9	8121	1	Screw driver (small)
10	8123	1	Oil
11	8125	1	Oiler
12	10780	1	Cotton stand
13	8124	1	Vinyl cover
14	13096	4	Machine base set screw

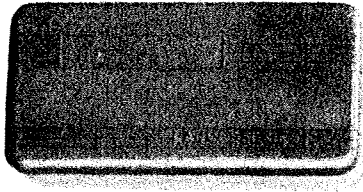

1

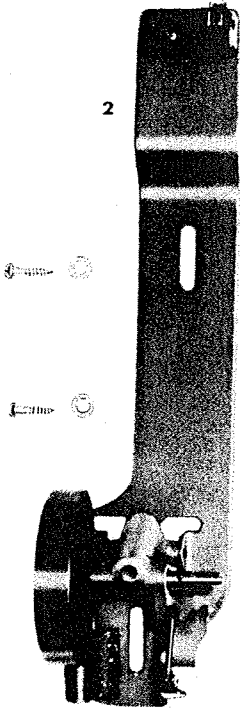

2



3

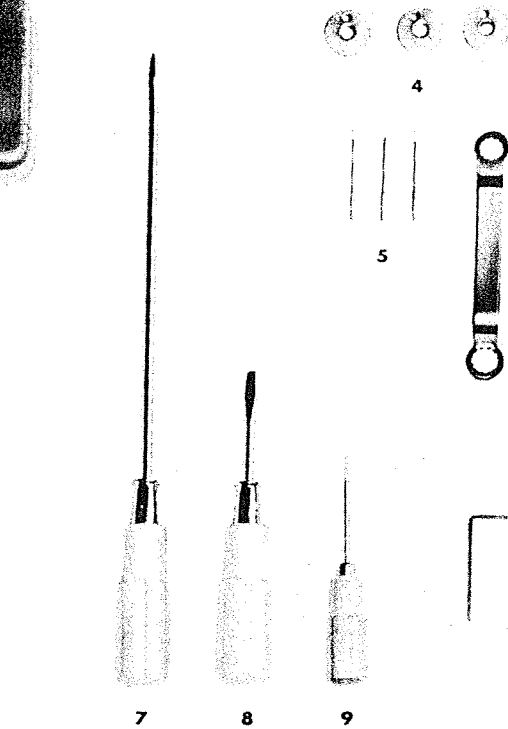
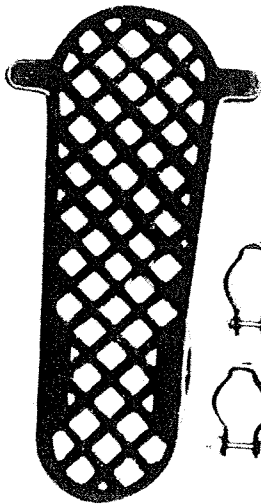

4

5

6

7

8

9



10



11

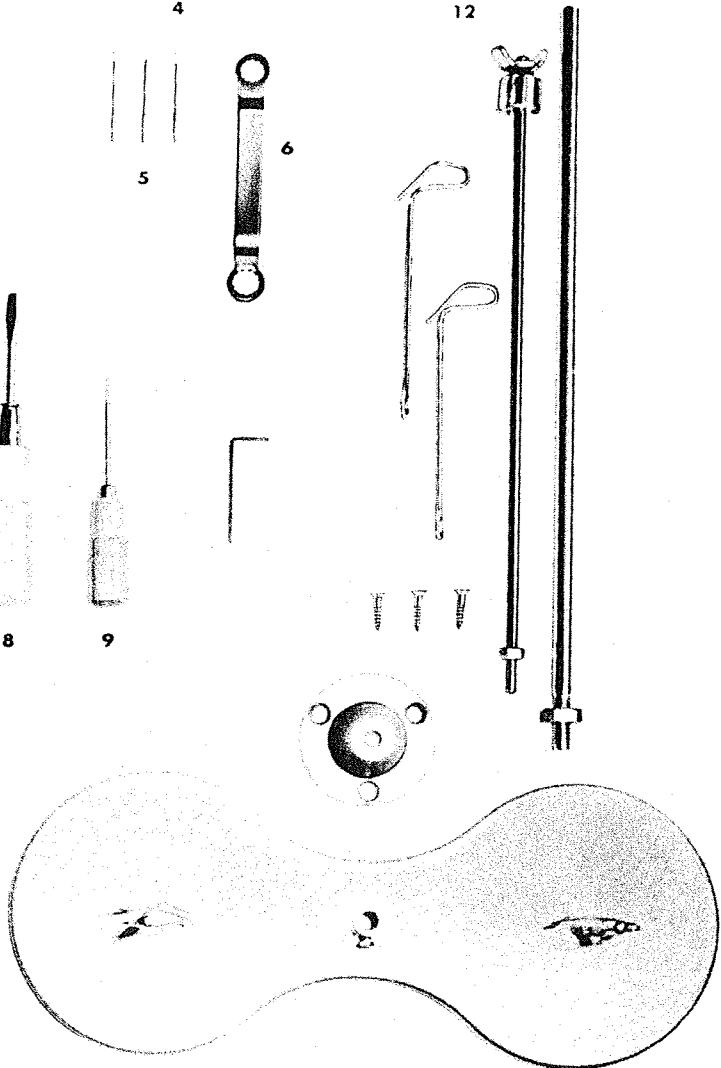

12

13

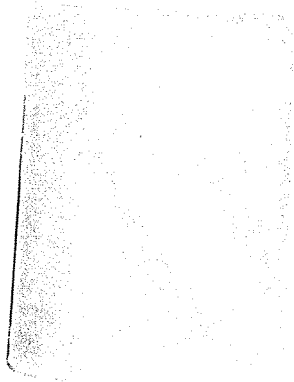

14

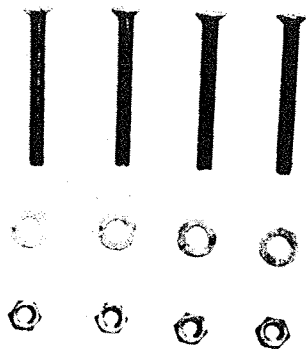

REVERSE STITCH MECHANISM FOR 223R, 227R & 227RFS

Fig. No.	Parts No.	Quantity	Name
1	10806	1	Reverse stitch lever spring
2	15076	1	Pin for 13419
3	13419	1	Spring hook for 10806
4	10566	2	Screw for 13075
5	13075	1	Arm shaft ball bearing adapter sleeve
6	10571	1	Screw for 13074
7	13074	1	Arm shaft bearing adapter
8	10567	1	Arm shaft ball bearing
9	10568	1	Ball bearing retaining washer
10	10506	1	Arm shaft oil packing stop screw
11	10724	1	Oil wick for 13422
12	13422	1	Arm shaft
13	10577	1	Balance wheel adjusting screw
14	10571	1	Screw for 13406
15	10521	1	Screw for 13407
16	10636	1	Nut for 10521
17	13406	1	Arm shaft bushing (middle)
18	10725	2	Oil wick for 13406
19	13407	1	Supporting bushing for 13413
20	13413	1	Feed motion regulator connection
21	11069	1	Oil wick for 13411 (small)
22	13411	1	Feed motion regulator
23	13412	2	Oil wick for 13411
24	8044	2	Stop screw for 13412
25	13409	1	Feed rod
26	10723	1	Oil wick presser
27	10722	1	Oil wick for 13410
28	13410	1	Feed rod link
29	13408	1	Feed eccentric
30	10566	2	Screw for 13408
31	13418	1	Stitch length indicator
32	7041	4	Screw for 13418
33	4041	1	Set screw for 13415 (large)
34	13415	1	Hinge screw for 13414
35	13417	1	Feed adjusting pipe
36	13416	1	Feed adjusting knurling tool
37	8157	1	Spring for 8158
38	8158	1	Bearing ball 1/8"
39	13414	1	Reverse stitch lever
40	8103	2	Screw for 13415 (small)
41	10576	1	Balance wheel set screw (A)
42	10579	1	Balance wheel set screw (B)
43	10504	1	Balance wheel
44	13423	1	Feed indicating disc
45	10566	1	Screw for 13423

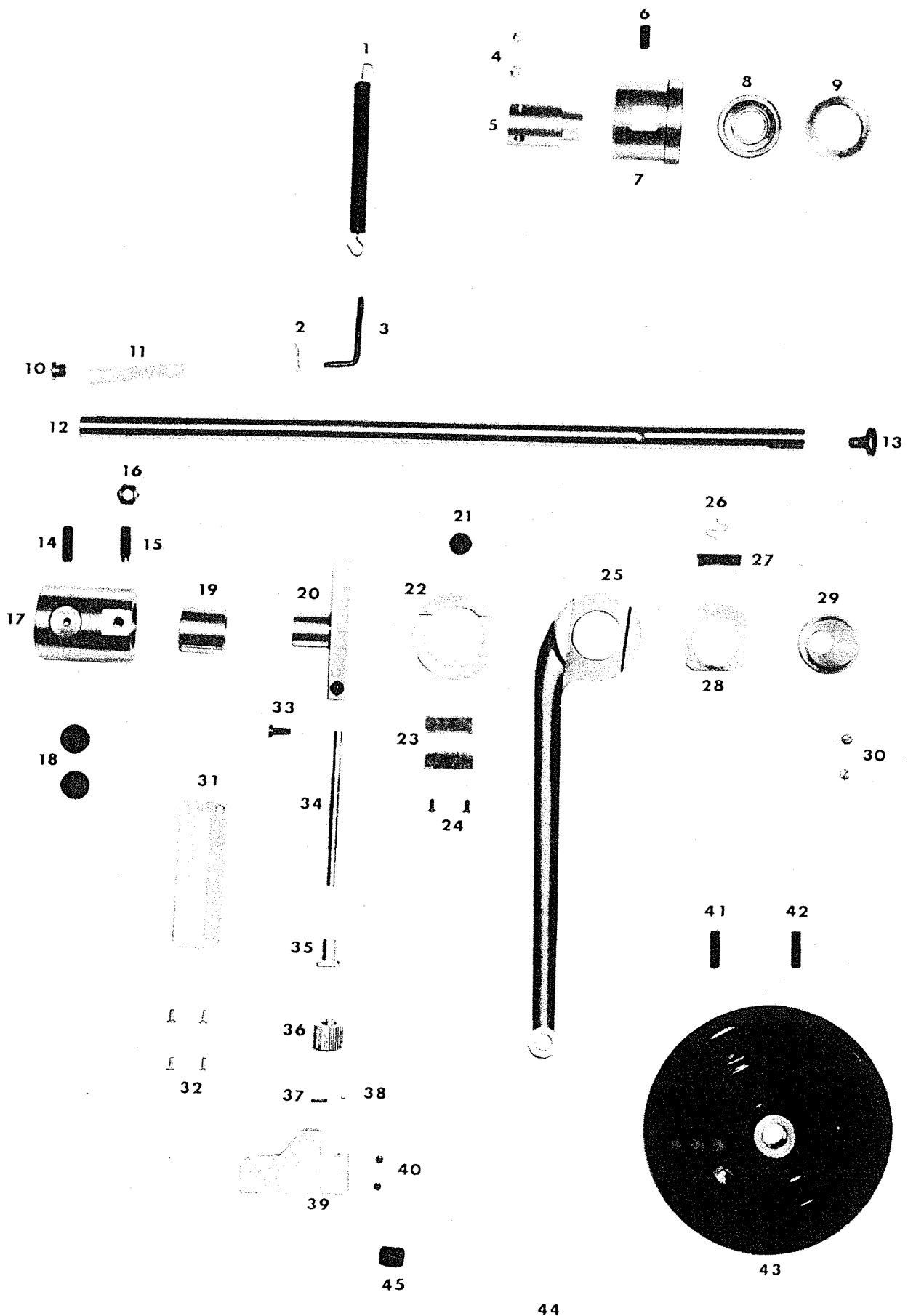

SPECIAL PARTS FOR 227FS & 227RFS

Fig. No.	Parts No.	Quantity	Name
1	13246	1	Lifting presser foot
2	13249	1	Vibrating presser foot
3	13240	1	Needle plate
4	13243	1	Feed dog
5	13252	1	Feed lifting fork
6	13253	1	Feed lifting fork cam
7	13234	2	Binder set nut
8	13235	2	Binder set washer
9	11823	1	Spring for 13221
10	8086	1	Screw for 13221
11	13221	1	Binder set plate
12	13218	1	Position screw for 13216
13	13217	1	Press pin for 13216
14	2067	1	Set screw for 13217
15	12128	1	Slide block for 13216
16	13219	2	Oil wick for 12128
17	13216	1	Binder oscillating plate
18	13207	1	Ball joint
19	13208	2	Ball pin
20	13212	1	Binder oscillating spindle
21	13209	1	Screw for 13208 (A)
22	13213	1	Bushing for 13212
23	2067	1	Screw for 13213
24	13206	1	Binder oscillating crank
25	2067	1	Screw for 13208 (B)
26	10545	1	Screw for 13206
27	10561	1	Screw for 13256
28	13235	1	Washer for 13256
29	13256	1	Tape guide
30	13204	1	Bed cover
31	8111	2	Screw for 13204
32	13003	1	Machine base
33	11830	1	Screw for 13261
34	13261	1	Collar for 13263
35	13263	1	Tape stand bar
36	13264	1	Nut for 13263
37	13260	1	Tape stand
38	10659	1	Presser bar lifting lever

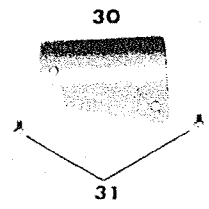
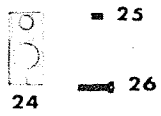
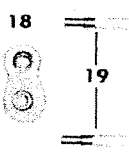
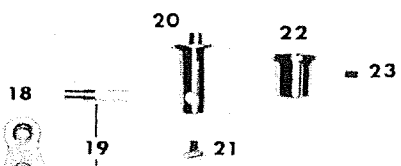
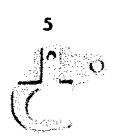
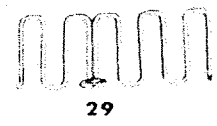
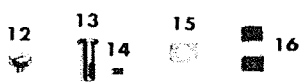
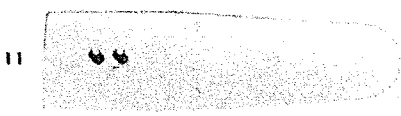
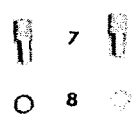
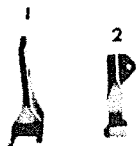

32

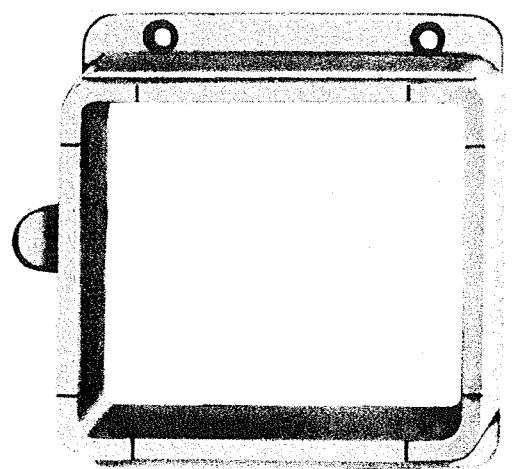

35

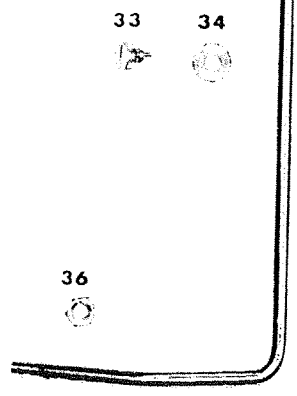

37

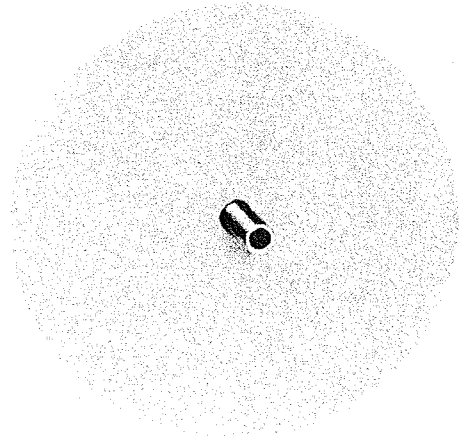

**PRESSER BAR, NEEDLE BAR, NEEDLE PLATE, FEEDER
FOR 223 & 223R ONLY**

Fig. No.	Parts No.	Quantity	Name
1	10540	1	Presser bar
2	10761	1	Screw for 10543
3	10543	1	Presser bar position guide
4	10538	1	Presser bar bushing (upper)
5	10761	2	Screw for 10538
6	10541	1	Presser bar position guide bracket
7	10662	1	Screw for 10541
8	10858	1	Washer for 10857
9	10857	1	Presser bar lifting bracket
10	10660	1	Presser bar lifter hinge screw
11	13055	1	Presser bar lifting lever
12	10532	1	Screw for 10549
13	10549	1	Presser bar spring bracket
14	10539	1	Presser bar bushing (lower)
15	13105	1	Presser foot
16	10664	1	Presser foot screw
17	10548	1	Presser bar lifting guide screw
18	10855	1	Needle bar rock frame
19	10726	1	Oil wick for 10856
20	10856	1	Needle bar connecting stud
21	10532	1	Screw for 10856
22	10859	1	Needle bar
23	10860	1	Needle bar thread guide
24	10534	1	Screw for 10860
25	10535	1	Needle set screw
26	6332	1	Needle
27	13104	1	Needle plate
28	13023	2	Needle plate set screw
29	13103	1	Feed dog
30	10561	1	Feed dog screw

